

## IR Receiver Modules for Remote Control Systems

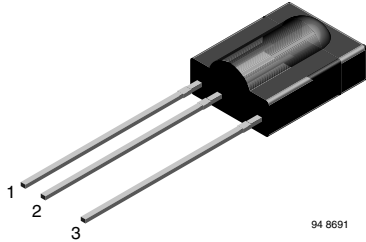

94 8691

### MECHANICAL DATA

#### Pinning:

1 = GND, 2 =  $V_S$ , 3 = OUT

### FEATURES

- Very low supply current
- Photo detector and preamplifier in one package
- Internal filter for PCM frequency
- Improved shielding against EMI
- Supply voltage: 2.5 V to 5.5 V
- Improved immunity against ambient light
- Insensitive to supply voltage ripple and noise
- Component in accordance to RoHS 2002/95/EC and WEEE 2002/96/EC



**RoHS**  
COMPLIANT

### DESCRIPTION

The TSOP12.. series are miniaturized receivers for infrared remote control systems. A PIN diode and a preamplifier are assembled on a lead frame, the epoxy package acts as an IR filter.

The demodulated output signal can be directly decoded by a microprocessor. The TSOP12.. is compatible with all common IR remote control data formats.

This component has not been qualified according to automotive specifications.

### PARTS TABLE

CARRIER FREQUENCY	STANDARD APPLICATION (AGC2/AGC8)
30 kHz	TSOP1230
33 kHz	TSOP1233
36 kHz	TSOP1236
36.7 kHz	TSOP1237
38 kHz	TSOP1238
40 kHz	TSOP1240
56 kHz	TSOP1256

### BLOCK DIAGRAM

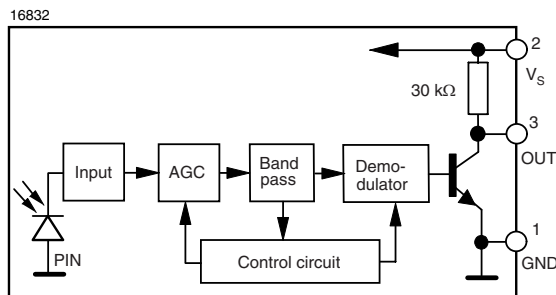

### APPLICATION CIRCUIT

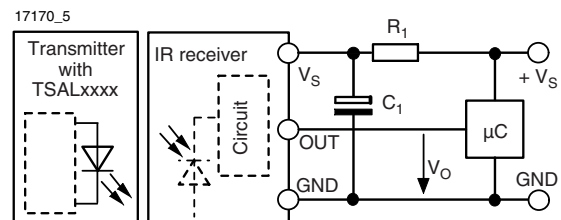

$R_1$  and  $C_1$  are recommended for protection against EOS. Components should be in the range of  $33 \Omega < R_1 < 1 \text{ k}\Omega$ ,  $C_1 > 0.1 \mu\text{F}$ .



ABSOLUTE MAXIMUM RATINGS (1)				
PARAMETER	TEST CONDITION	SYMBOL	VALUE	UNIT
Supply voltage (pin 2)		$V_S$	- 0.3 to + 6.0	V
Supply current (pin 2)		$I_S$	3	mA
Output voltage (pin 3)		$V_O$	- 0.3 to ( $V_S + 0.3$ )	V
Output current (pin 3)		$I_O$	5	mA
Junction temperature		$T_j$	100	°C
Storage temperature range		$T_{stg}$	- 25 to + 85	°C
Operating temperature range		$T_{amb}$	- 25 to + 85	°C
Power consumption	$T_{amb} \leq 85$ °C	$P_{tot}$	10	mW
Soldering temperature	$t \leq 10$ s, 1 mm from case	$T_{sd}$	260	°C

### Note

(1) Stresses beyond those listed under "Absolute Maximum Ratings" may cause permanent damage to the device. This is a stress rating only and functional operation of the device at these or any other conditions beyond those indicated in the operational sections of this specification is not implied. Exposure to absolute maximum rating conditions for extended periods may affect the device reliability.

ELECTRICAL AND OPTICAL CHARACTERISTICS (1)						
PARAMETER	TEST CONDITION	SYMBOL	MIN.	TYP.	MAX.	UNIT
Supply voltage		$V_S$	2.5		5.5	V
Supply current (pin 2)	$E_v = 0, V_S = 3.3$ V	$I_{SD}$	0.27	0.35	0.45	mA
	$E_v = 40$ klx, sunlight	$I_{SH}$		0.45		mA
Transmission distance	$E_v = 0$ , test signal see fig. 1, IR diode TSAL6200, $I_F = 250$ mA	$d$		45		m
Output voltage low (pin 3)	$I_{OSL} = 0.5$ mA, $E_e = 0.7$ mW/m <sup>2</sup> , test signal see fig. 1	$V_{OSL}$			100	mV
Minimum irradiance	Pulse width tolerance: $t_{pi} - 5/f_o < t_{po} < t_{pi} + 6/f_o$ , test signal see fig. 1	$E_e$ min.		0.15	0.35	mW/m <sup>2</sup>
Maximum irradiance	$t_{pi} - 5/f_o < t_{po} < t_{pi} + 6/f_o$ , test signal see fig. 1	$E_e$ max.	30			W/m <sup>2</sup>
Directivity	Angle of half transmission distance	$\phi_{1/2}$		$\pm 45$		deg

### Note

(1)  $T_{amb} = 25$  °C, unless otherwise specified

## TYPICAL CHARACTERISTICS

$T_{amb} = 25$  °C, unless otherwise specified

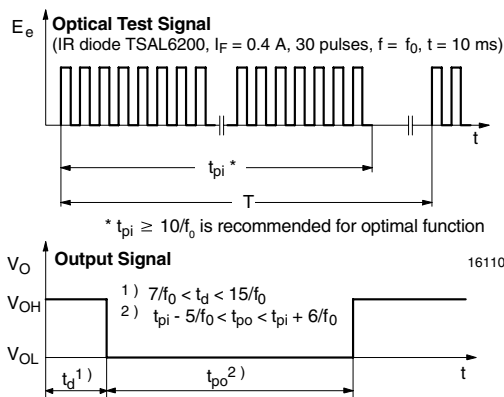

Fig. 1 - Output Active Low

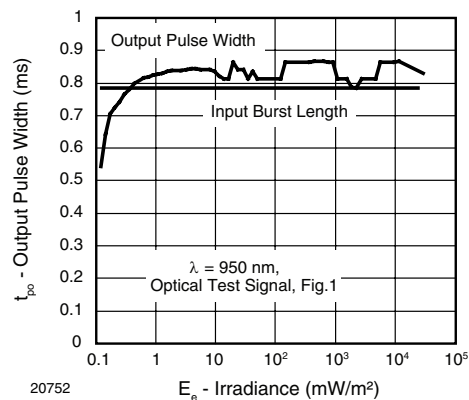

Fig. 2 - Pulse Length and Sensitivity in Dark Ambient



Fig. 3 - Output Function

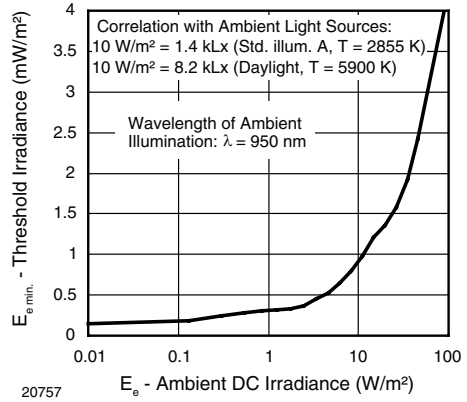

Fig. 6 - Sensitivity in Bright Ambient

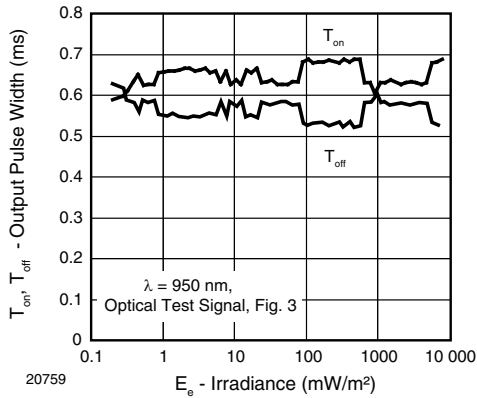

Fig. 4 - Output Pulse Diagram

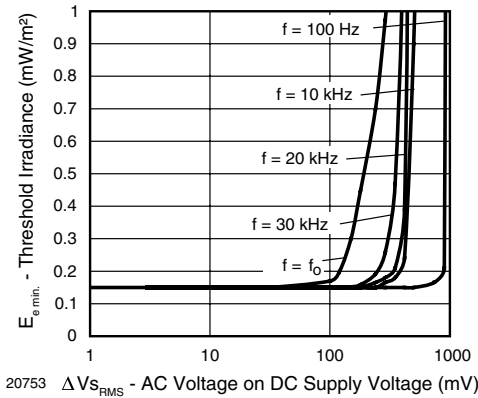

Fig. 7 - Sensitivity vs. Supply Voltage Disturbances

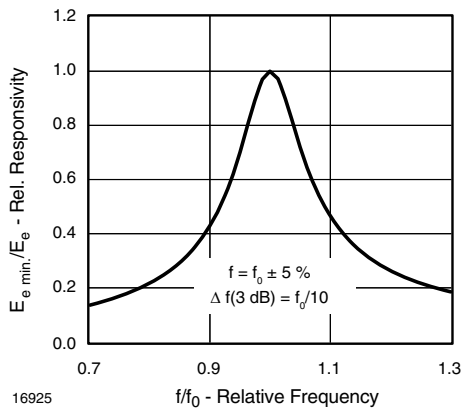

Fig. 5 - Frequency Dependence of Responsivity

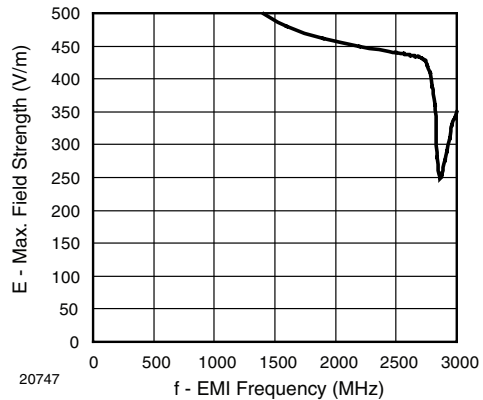

Fig. 8 - Sensitivity vs. Electric Field Disturbances

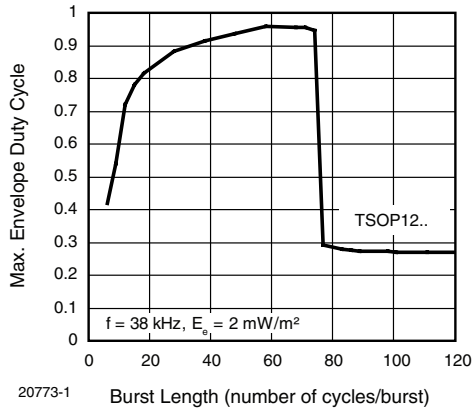

Fig. 9 - Max. Envelope Duty Cycle vs. Burst Length

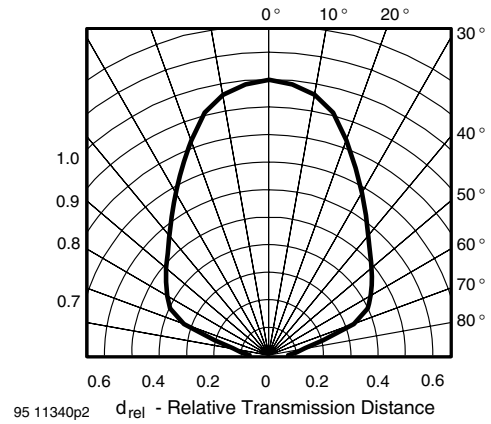

Fig. 12 - Horizontal Directivity

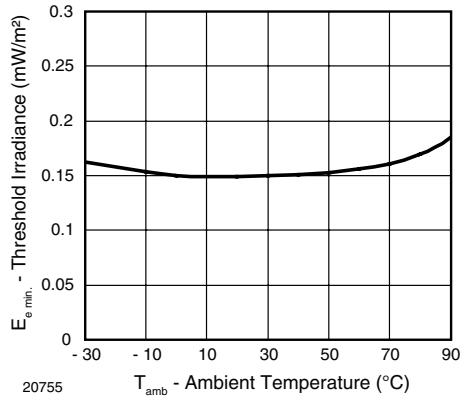

Fig. 10 - Sensitivity vs. Ambient Temperature

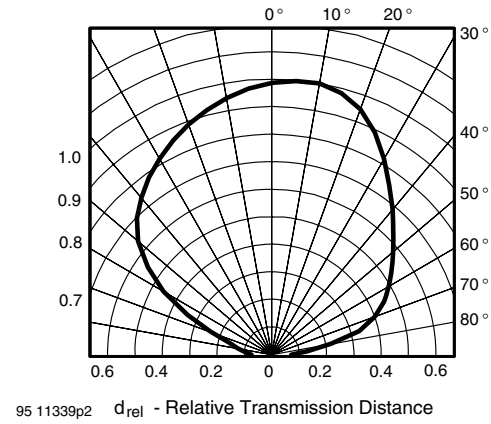

Fig. 13 - Vertical Directivity

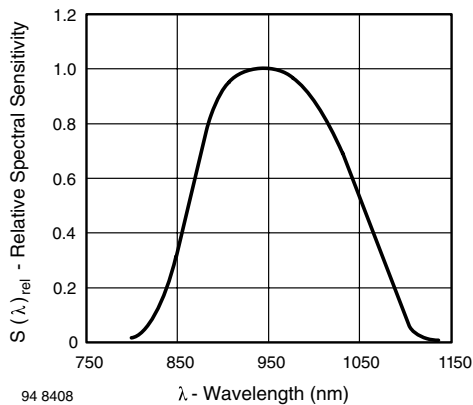

Fig. 11 - Relative Spectral Sensitivity vs. Wavelength

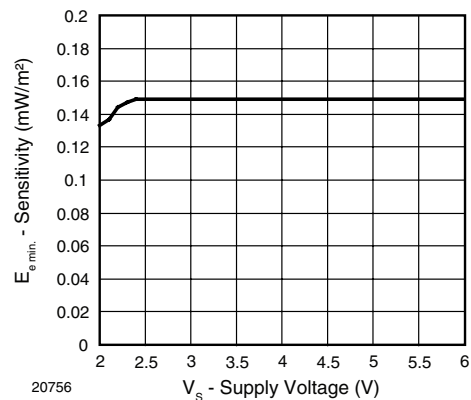

Fig. 14 - Sensitivity vs. Supply Voltage

**SUITABLE DATA FORMAT**

The TSOP12.. series is designed to suppress spurious output pulses due to noise or disturbance signals. Data and disturbance signals can be distinguished by the devices according to carrier frequency, burst length and envelope duty cycle. The data signal should be close to the band-pass center frequency (e.g. 38 kHz) and fulfill the conditions in the table below.

When a data signal is applied to the TSOP12.. in the presence of a disturbance signal, the sensitivity of the receiver is reduced to insure that no spurious pulses are present at the output. Some examples of disturbance signals which are suppressed are:

- DC light (e.g. from tungsten bulb or sunlight)
- Continuous signals at any frequency
- Strongly or weakly modulated noise from fluorescent lamps with electronic ballasts (see figure 15 or figure 16)

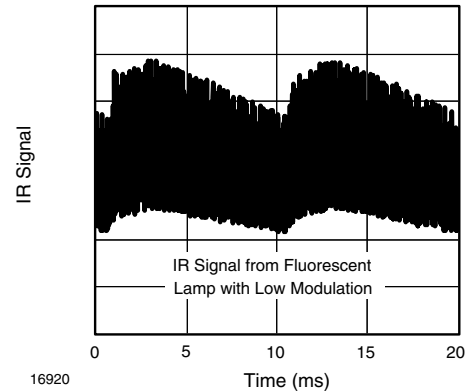

Fig. 15 - IR Signal from Fluorescent Lamp with Low Modulation

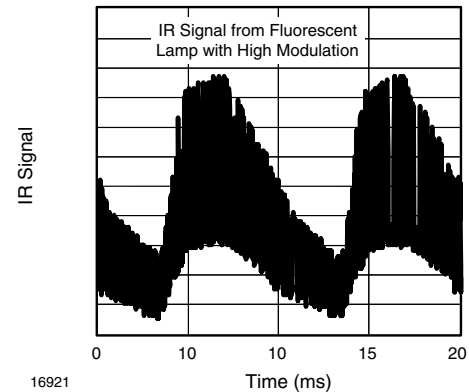

Fig. 16 - IR Signal from Fluorescent Lamp with High Modulation

	<b>TSOP12..</b>
Minimum burst length	10 cycles/burst
After each burst of length a minimum gap time is required of	10 to 70 cycles ≥ 10 cycles
For bursts greater than a minimum gap time in the data stream is needed of	70 cycles > 4 x burst length
Maximum number of continuous short bursts/second	1800
Recommended for NEC code	yes
Recommended for RC5/RC6 code	yes
Recommended for Sony code	yes
Recommended for Thomson 56 kHz code	yes
Recommended for Mitsubisi code (38 kHz, preburst 8 ms, 16 bit)	yes
Recommended for Sharp code	yes
Suppression of interference from fluorescent lamps	Most common disturbance signals are suppressed

**Note**

For data formats with short bursts please see the data sheet for TSOP11..., TSOP13.

# New TSOP12..

Vishay Semiconductors

IR Receiver Modules for  
Remote Control Systems



## PACKAGE DIMENSIONS in millimeters

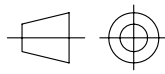
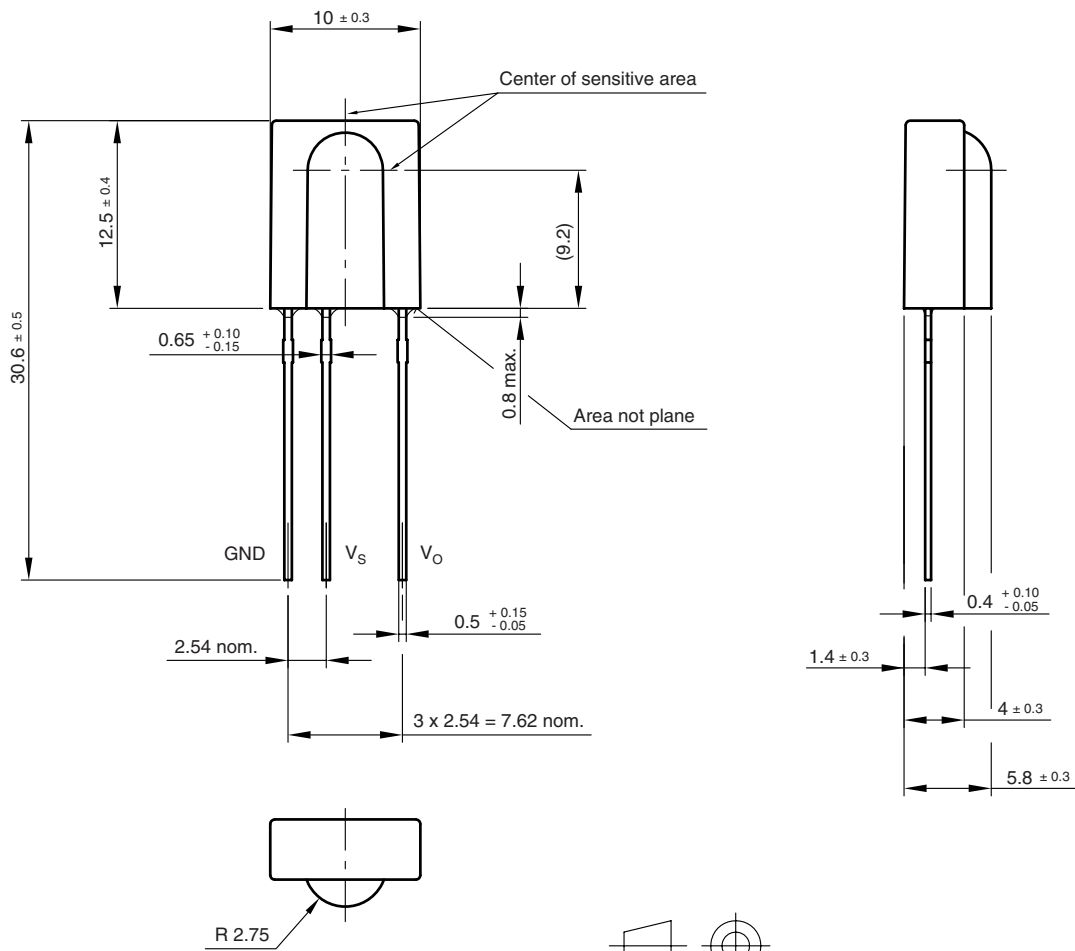

technical drawings  
according to DIN  
specifications

Drawing-No.: 6.550-5095.01-4

Issue: 19; 16.12.08

96 12116



## Disclaimer

All product specifications and data are subject to change without notice.

Vishay Intertechnology, Inc., its affiliates, agents, and employees, and all persons acting on its or their behalf (collectively, "Vishay"), disclaim any and all liability for any errors, inaccuracies or incompleteness contained herein or in any other disclosure relating to any product.

Vishay disclaims any and all liability arising out of the use or application of any product described herein or of any information provided herein to the maximum extent permitted by law. The product specifications do not expand or otherwise modify Vishay's terms and conditions of purchase, including but not limited to the warranty expressed therein, which apply to these products.

No license, express or implied, by estoppel or otherwise, to any intellectual property rights is granted by this document or by any conduct of Vishay.

The products shown herein are not designed for use in medical, life-saving, or life-sustaining applications unless otherwise expressly indicated. Customers using or selling Vishay products not expressly indicated for use in such applications do so entirely at their own risk and agree to fully indemnify Vishay for any damages arising or resulting from such use or sale. Please contact authorized Vishay personnel to obtain written terms and conditions regarding products designed for such applications.

Product names and markings noted herein may be trademarks of their respective owners.